

Technische Daten:

Werkstoff:

Polyamid

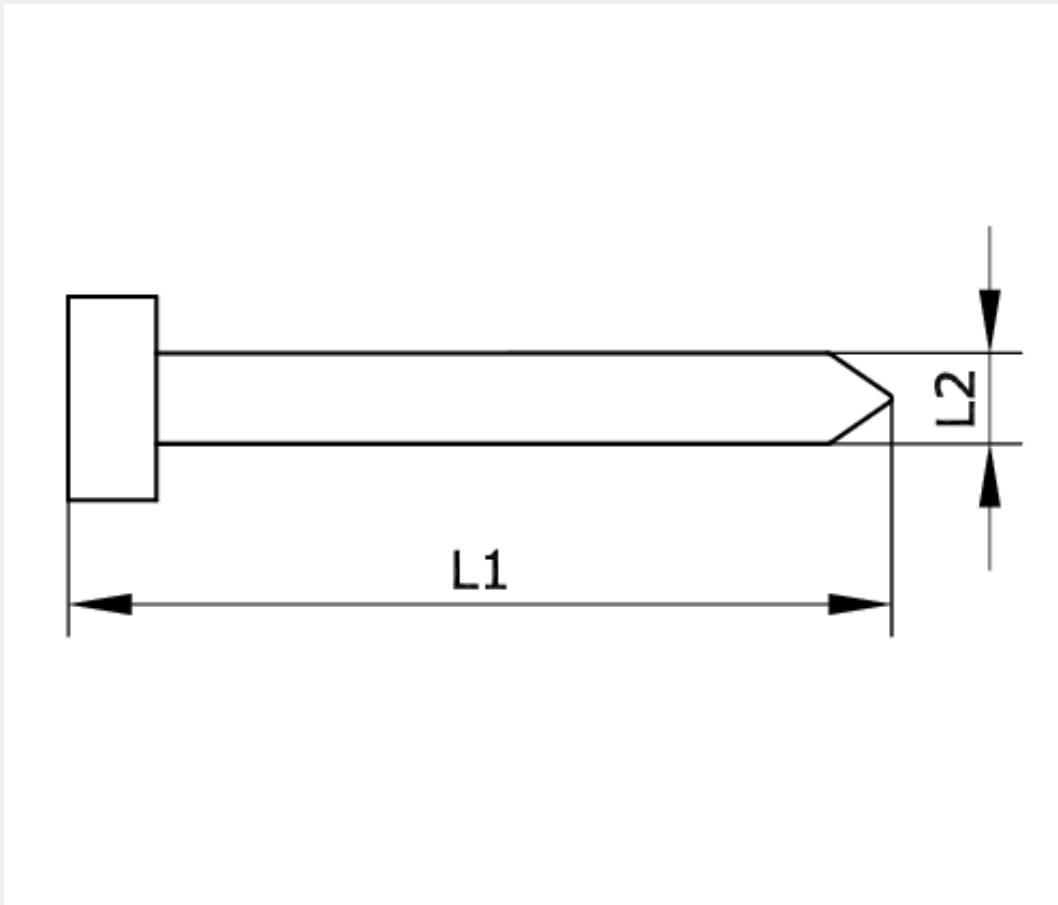

Artikelnummer	Abmessung	L1	L2
260991	4,8 x 450	450	4,8

max. Binde-Ø
134